

**OWNER'S  
INSTRUCTION MANUAL**



*Colleague* **CALLER ID TYPE II  
DISPOSITION PLUS  
TELEPHONE**

MODEL 2200

**CORTELCO**

**THANK YOU  
FOR PURCHASING THE  
COLLEAGUE CALLER ID TYPE II  
DISPOSITION PLUS TELEPHONE**

**We want you to know all about your new Colleague Telephone,** how to install it, the features it provides, and the services you can expect from its use. We have included this information in your Owner's Instruction Manual.

**PLEASE READ BEFORE INSTALLING  
AND USING YOUR NEW TELEPHONE EQUIPMENT.**

# TABLE OF CONTENTS

<b>IMPORTANT SAFETY INSTRUCTIONS .....</b>	<b>iv</b>
<b>TELEPHONE USAGE .....</b>	<b>1</b>
INSTALLATION.....	1
24/90V MESSAGE WAITING LAMP.....	2
WALL MOUNT INSTRUCTIONS.....	3
FACTORY PRESETS .....	3
SETUP.....	4
<b>TELEPHONE PART IDENTIFICATION .....</b>	<b>5</b>
<b>TELEPHONE FEATURES .....</b>	<b>7</b>
PULSE AND TONE DIALING.....	7
RECEIVING A PHONE CALL.....	7
PLACING A PHONE CALL.....	7
SPEAKER PHONE BUTTON.....	7
DURATION COUNTER.....	8
MUTE BUTTON.....	8
AUTOMATIC MEMORY .....	8
TO STORE A PHONE NUMBER IN MEMORY.....	8
TO DIAL A PHONE NUMBER IN MEMORY.....	9
VOLUME BUTTON.....	9
REDIAL BUTTON.....	9
PAUSE BUTTON.....	9
HOLD BUTTON.....	10
FLASH BUTTON.....	10
HEADSET COMPATIBLE.....	10
DATA PORT.....	10
CALL WAITING DISPLAY.....	10

<b>CALLERIDFEATURES .....</b>	<b>11</b>
MESSAGE LIGHT .....	11
MESSAGE WAITING .....	11
RECEIVING CALLS .....	12
REVIEWING CALLS .....	13
DELETING CALLS .....	13
CALLBACK.....	14
OPTIONS BUTTON .....	14
MESSAGE ERROR .....	16
NODATA SENT .....	16
PRIVATE CALLS .....	16
UNKNOWN CALLS .....	17
CALL WAITING DELUXE .....	17
<b>TELEPHONE SERVICE PROBLEMS .....</b>	<b>18</b>
<b>MAINTENANCE INFORMATION .....</b>	<b>19</b>
<b>TELEPHONE REPAIR .....</b>	<b>20</b>
<b>FCC INFORMATION .....</b>	<b>21</b>

## IMPORTANT SAFETY INSTRUCTIONS

**Always follow basic safety precautions** when using your telephone equipment to reduce the risk of fire, electrical shock, and injury.

1. **Read and understand all instructions** in the Owner's Instruction Manual.
2. **Read all warnings** and follow all instructions marked on the product.
3. **Unplug this product from the wall outlet before cleaning.** Use a damp cloth for cleaning. Do not use liquid or aerosol cleaners.
4. **Do not use the telephone near water.** For example, do not use near a bathtub, wash bowl, kitchen sink, laundry tub, swimming pool, or in a wet basement.
5. **Do not place this product on an unstable cart or stand.** The product may fall causing serious damage to the product.
6. **Use only the type power source indicated on the label.** If you are not sure of the type power supply to your home, consult your dealer or local power company.
7. **Do not place any objects on the telephone line cord.** Do not locate the telephone where the line cord will be walked on.
8. **Do not block or cover ventilation slots and openings** in the bottom of the telephone. The openings should never be blocked by placing the telephone on a bed, sofa, rug, or other similar surfaces. The telephone should never be placed near or over a radiator or heat register. The telephone should never be placed in a built-in installation unless proper ventilation is provided.
9. **Never spill liquid on the telephone or push objects of any kind through ventilation slots.** Liquid or objects may touch dangerous voltage points or short out parts that could result in a risk of fire or electrical shock.

10. **Do not disassemble this product.** Opening or removing covers may expose you to dangerous voltages or other risks. Incorrect reassembly can cause electrical shock when the product is subsequently used.
11. **Do not overload outlets and extension cords.** Some telephones require AC power from an outlet. Overloading the outlets can result in the risk of fire or electric shock.
12. **Avoid using a telephone during a local thunderstorm.** There may be a remote risk of electrical shock from lightning. The spec. of fuse (F1) is 0.5A/250V delay time .
13. **Do not use a telephone to report a gas leak in the vicinity of the leak.**
14. **Unplug the telephone from the wall outlet and refer servicing to qualified service personnel** under the following conditions:
  - When the line cord is frayed or plugs damaged.
  - If liquid has been spilled into the telephone.
  - If the telephone has been exposed to rain or water.
  - If the telephone does not operate properly by following the operating instructions. (Adjust only those controls covered by the operating instructions. Improper adjustment of other controls may result in damage and will often require extensive work by a qualified technician to restore the product to normal operation.)
  - If the telephone has been dropped or the housing damaged.
  - If the telephone exhibits distinct change in performance.

**CAUTION-Always disconnect all telephone lines from the wall outlet before servicing or disassembling this equipment.**

**SAVE THESE INSTRUCTIONS**

15-101-613

# TELEPHONE USAGE

## INSTALLATION

1. Connect the adapter. Plug the large part of the adapter into the wall outlet and the adapter tip to the jack at the rear side of unit. (Use only 9V DC, 200mA, center positive Class 2 adapter.)
2. Connect the telephone line cord.
  - a. To connect without an answering machine.
    - Use the new line cord to connect the PHONE jack of your new caller ID phone to the modular wall jack.

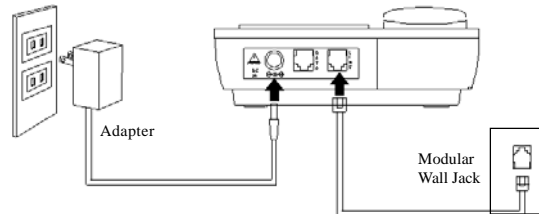

- b. To connect with an existing answering machine.
  - Use the existing line cord supplied to connect the LINE jack of your answering machine to the wall modular line jack.
  - Use the new line cord supplied to connect the telephone's jack of your new Caller ID phone to the PHONE jack of your answering machine.
  - Set your answering machine to answer the phone after 2 or more rings.

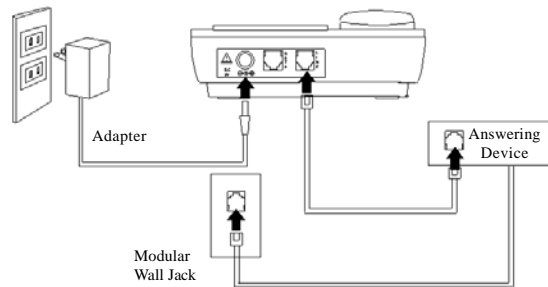

3. Follow the procedure "*Unit Setup*" to set up your unit.
4. Place the unit on a flat table or mount it on a wall. If you desire to place it on a wall, use the wall mount bracket and short line cord supplied to accomplish the wall mounting.

## 24/90V MESSAGE WAITING LAMP

If your phone is installed behind a Message Waiting enabled PBX, you will need to set the MW switch in order to receive the Message Waiting indication.

1. Remove the directory cover by moving the holding clip up, and pulling the clear cover up.
2. Once the directory cover is removed, locate the switch below the holding clip.
3. For 90V PBX Message Waiting Indication, move the switch to the position marked "90V". For 24V PBX Message Waiting Indication, move the switch to the position marked "24V". If connecting directly to telephone lines, move the switch to the center "OFF" position.
4. Replace and secure the directory cover by placing the directory cover on and moving the holding clip down.

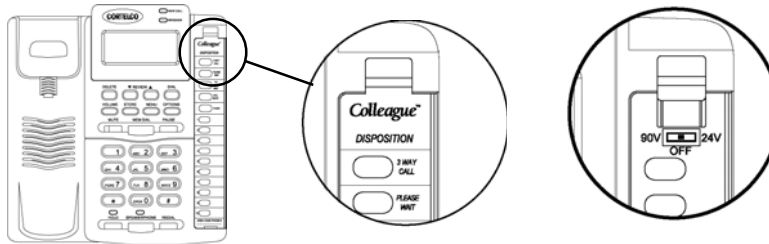

**Warning: Setting this switch in a position other than OFF can cause this phone to function incorrectly. When enabled, this feature is for PBX systems, and not meant for direct Central Office (CO) interface. If connecting to CO telephone lines, make sure this switch is set to OFF.**



### WALL MOUNT INSTRUCTIONS

1. Install wall mount bracket in wall mount position and route cords as shown in diagram below.
2. Connect the adapter and the line cord. See Steps 2 & 3 on preceding page for specific instructions.
3. Push out the handset hook and reattach in opposite direction for the wall mount position, plug the coiled cord into the handset, and then plug the other end of the cord into the case.
4. Place the handset on the base.

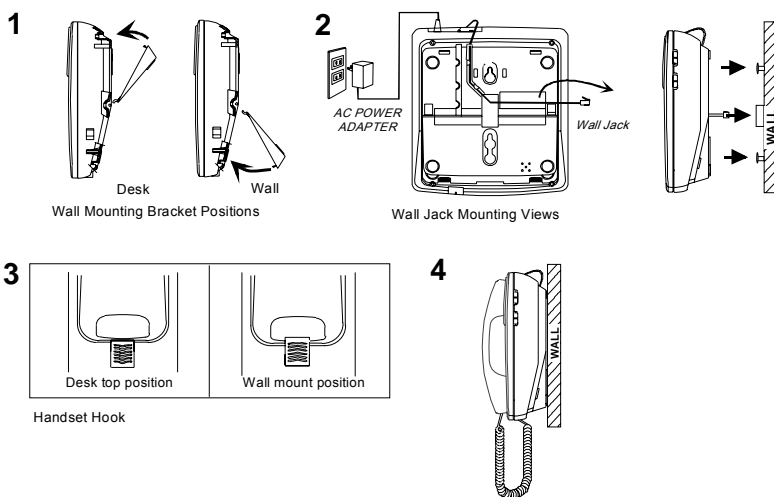

### FACTORY PRESETS

The following table shows you the factory settings for your unit:

Display	Setting
Language	English
LCD Contrast	2
Area Code	no setting
LDS Code	1
Access Code	—

*Note: After you have set up the unit completely for the first time, use the **MENU** button to review or reprogram the Language, Contrast, Area Code, LDS Code or Access Code.*

## SETUP

After the adapter is connected, the display will show as indicated below for setting

1. [SET LANGUAGE] appears on the display. Press the **REVIEW UP** (▲) button to select the language. E - English, F - French, S - Spanish, and then press the **DIAL** button to confirm the selection.

E  
**SET LANGUAGE**

2. When [LCD CONTRAST] appears, press **REVIEW UP** (▲) button to set the contrast darker, and then you can press **REVIEW DOWN** (▼) button to set the contrast back to the preset.

2  
**LCD CONTRAST**

3. When [SET AREA CODE] appears, use **REVIEW UP** (▲) button and **REVIEW DOWN** (▼) button to set your local area code.

- - -  
**SET AREA CODE**

**REVIEW UP** (▲) button - to change the digit from -. 0, 1, 2, -9

**REVIEW DOWN** (▼) button - to move to the next digit.

When you are finished setting the local area code, press **Dial**.

4. When [SET LDS CODE] appears, press **REVIEW UP**(▲) button to change the long distance code from -, 0, 1, 2, -9. When you are finished, Press **DIAL**. The display will indicate as shown (Stand-By Screen) and be ready to receive incoming calls. You have to set the LDS code as 1 when you are in the USA or Canada.

1  
**SET LDS CODE**

**Standby Screen**

5. When [SET ACCESS CODE] appears, use **REVIEW UP** (▲) button to set your access code. The Code can range from \_ to 9. The Access Code is used to obtain an outside line when using a PBX and some Centrex applications. This feature can be used with Caller ID and Memory Locations.
6. The time and date are automatically set when a caller ID (CID) number is received. The unit will keep the current time accurately, and is updated each time a CID number is received.

# TELEPHONE PART IDENTIFICATION

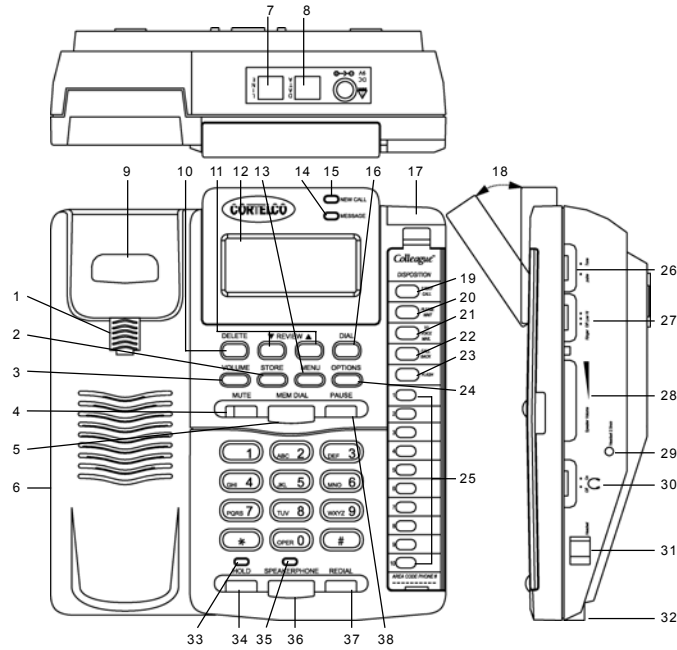

1	Handset Hook	20	Please Wait Button
2	Store Button	21	To Voice Mail Button
3	Volume Button	22	Call Back Button
4	Mute Button	23	Flash Button
5	Memory Dial Button	24	Options Button
6	Handset Cord Jack	25	10 Auto Memory Buttons
7	Line Cord Jack	26	Tone / Pulse Switch
8	Data Cord Jack	27	Ringer Volume Switch
9	Hook Switch	28	Speakerphone Volume
10	Delete Button	29	2.5mm Headset Jack
11	Review Up/Down Buttons	30	Headset On/Off Switch
12	LCDDisplay	31	RJ-Type Headset Jack
13	Menu Button	32	Microphone
14	Green Message / Extension In Use LED	33	Hold LED
15	Red New Call LED	34	Hold Button
16	Dial Button	35	Speakerphone/Headset LED
17	PBX 24/90V Message LED	36	Speakerphone/Headset Button
18	Multi-Angle Display	37	Redial Button
19	3-Way Call Button	38	Pause Button

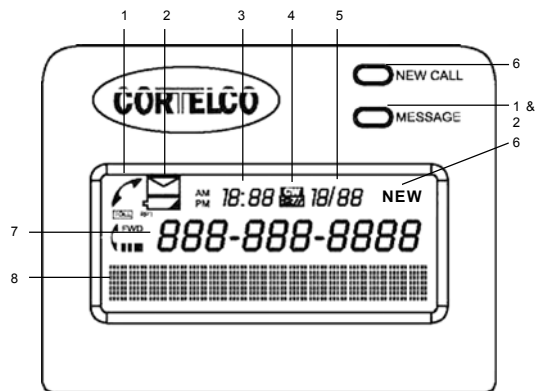

1	Extension In Use icon. This icon displays, along with the MESSAGE LED whenever any phone is using the phone line.
2	Voice Mail Message Waiting. When using Central Office Voice Mail, this icon displays and the MESSAGE LED illuminates when a new message is waiting.
3	Current Time
4	CW displays when you receive a call on the same line you are currently using (Call Waiting)
5	Current Date
6	NEW displays and the NEW CALL LED illuminates when new Caller ID data is received. To clear this icon and turn off the NEW CALL LED, you need to review the Caller ID information.
7	Phone number data of incoming and outgoing calls.
8	Alpha/numeric data. Displays Caller ID names, phone status, and line status.

# TELEPHONE FEATURES

## **PULSE AND TONE DIALING**

1. If your telephone line accepts a touch-tone dialing, set the **PULSE/TONE** switch to the Tone position.
2. If your telephone line requires a rotary (pulse) dialing, set the **PULSE/TONE** switch to the Pulse position.
3. If you are unsure which system you have, set the switch to the **TONE** position. Lift the handset. When you get a dial tone, dial a telephone number. If the dial tone continues, move the switch to **PULSE**, and then dial the telephone number again.

**Note:** In order for the Caller ID callback to work (see *Using the Caller ID Function*), you must set the **PULSE/TONE** switch to the Tone position.

## **RECEIVING A PHONE CALL**

1. Be sure the **RINGER** switch is set to the **HI** or **LOW** position.
2. When the phone rings and the caller's information shows on the display window (refer to *Using the Caller ID Function*), lift the handset or press the **SPEAKERPHONE** button and begin your conversation.
3. Set the Ringer switch to the **OFF** position when you do not want to be interrupted by the phone ringing. Remember to set the ringer switch back to Hi or Low when you want to receive calls again.

## **PLACING A PHONE CALL**

1. Lift the handset or press the **SPEAKERPHONE** button and wait for a dial tone.
2. Dial the telephone number you wish to call. The number will appear on the display window.

## **SPEAKERPHONE BUTTON** (AC Adaptor must be used to ensure proper function)

1. Receiving Incoming Calls
  - a. When the phone rings and the callers information shows on the display window (refer to *Using the Caller ID Function*), press and release the Speakerphone button and talk normally into the built-in microphone from a distance of 5-6 inches.

- b. You can adjust the volume of the callers voice by sliding the **VOLUME CONTROL** on the right side of the phone.
  - c. After the conversation has finished, press the **SPEAKERPHONE** button to hang up.
2. To Make A Call
  - a. Press and release the **SPEAKERPHONE** button.
  - b. When you hear a dial tone, dial the number or press the auto memory button just as you would on any other push-button telephone. The number will appear on the display window.
  - c. When your party answers, adjust the sound level of his or her voice by sliding the **VOLUME CONTROL** located on the right side of the phone.
  - d. After the conversation has finished, press **SPEAKERPHONE** to hang up.

#### **DURATION COUNTER**

A built-in counter will start counting from your reference 6 seconds after you lift the handset or 6 seconds after you dial a telephone number.

#### **MUTE BUTTON**

Press **MUTE** to speak without the person on the phone hearing your conversation. The **MUTE** Indicator will light up and remain lighted until you resume your conversation. To resume your conversation, press **MUTE**. The **MUTE** indicator will go out and your call can continue.

#### **AUTOMATIC MEMORY**

To Store A Number In Memory:

1. Press the **STORE** button, [**MEMORY STORING**] appears on the display window.
2. Dial the telephone number (16 digits maximum) to store in **memory**.  
*Note: The memory locations can be chained together to store numbers of longer length.*
3. Press **STORE** again.
4. Press the desired memory location.
  - To store in an auto memory button (located on right-hand side of base) - Press 1, 2, 3, ..., or 10).

- To store in a keypad memory location - Press one of the keypad buttons (1, 2, 3, or 0).
5. Use pull out memory index to write in name and the memory button where it is stored.

#### To Dial A Phone Number In Memory

1. Lift the handset and wait for a dial tone.
2. Press any memory location.
  - To dial an auto memory button (located on right-band side of base) - Press the desired auto memory button (1, 2, 3.... or 10).
  - To dial a keypad memory location - press the **MEM DIAL** button first, and then the desired keypad button (1, 2, 3.... or 0).
3. The number will be displayed and dialed automatically.

#### **VOLUME BUTTON**

A built-in amplifier feature allows you to increase the listening volume in the receiver of the handset when speaking with your party. When needed, press the **VOLUME** button to achieve four different levels.

#### **REDIAL BUTTON**

1. If the number you dialed is busy, or you want to call the last number dialed again, lift the handset, or press and release the hookswitch for a new dial tone.
2. Press **REDIAL**. The number will appear on the display window.
3. The last number called (32 digits maximum) will automatically be redialed.

#### **PAUSE BUTTON**

The **PAUSE** button allows you to insert a 3.6-second pause in the dialing sequence. This is particularly useful if you are connected to a PABX system where you must dial an access code (usually the number 9) to obtain an outside line.

1. Press the **PAUSE** button once and release at any point in the dialing sequence where a pause is desired.
2. The **PAUSE** button can be pressed more than once to create a longer pause.

### **HOLD BUTTON**

1. To place a call on hold, press the **HOLD** button and hang up the handset. The **HOLD** Indicator will light up and remain lighted until you resume your conversation.
2. To resume your conversation, lift the handset or that of any extension phone on the same line or press and release **SPEAKERPHONE**. The **HOLD** indicator will go out and your call can continue.

### **FLASH BUTTON**

This telephone provides a line break signal for accessing PABX service or for convenient use of Call Waiting from your local telephone company. If you have Call Waiting service, you can alternate the Call Waiting function per the following instructions.

1. While having a conversation, another party calls and you hear a tone.
2. Press the **FLASH** button once and release. The first conversation is placed on hold and the second call can be answered.
3. Press **FLASH** button again and release. The first caller can be spoken to again and the second call is placed on hold.

Flash can also be used when storing numbers in memory locations to transfer a call to a new extension.

***Note:** If you also have subscribed to Call Waiting Caller ID service, please see Call Waiting Display below*

### **HEADSET COMPATIBLE**

This telephone will accept a 2.5mm cell phone-style headset or an RJ-type headset. To enable headset mode, move the switch on the right side of the phone (see Page 7 for switch location) to the ON position. The **SPEAKERPHONE** button is used to connect or disconnect from a call.

***Note:** With the headset switch turned to the ON position, the speakerphone feature will be disabled.*

### **DATA PORT**

This is a connection which is in parallel with the telephone line. It allows the connection of a device such as a modem, caller ID, or an answering machine.

### **CALL WAITING DISPLAY**

In the past, if you had call-waiting service, a tone alerted you there was a new call coming while you were on an existing call.

Now our Call Waiting Caller ID not only tells you there is another call waiting, but lets you



know who the caller is before you answer it. The call waiting information will be shown on the unit's display.

The **CALL WAITING** (CW) symbol will flash for 16 seconds along with the telephone number and name of the person who is on call waiting. Press the FLASH button to put the existing call on hold and answer the new call.

No matter whether you answer the call or not, the Call Waiting Caller ID will store the call information for future reference.

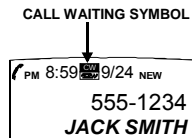

**Note:** Make sure you have subscribed to both Call Waiting Caller ID and Caller ID service from your local telephone company. If you only have Caller ID service, the unit works for Caller ID only.

## CALLER ID FEATURES

### MESSAGE LIGHT

An indicator marked **NEW CALL** will light up to let you know when there are new calls received.

If you have a voice mailbox service with your telephone company, another indicator marked **MESSAGE** will flash to alert you to dial your telephone company to check your new messages.

The **MESSAGE** indicator also monitors the unit's situation. When the phone is in use, the **MESSAGE** indicator will be on continuously. If the indicator is flashing quickly, it means the phone is ringing. If it is not ringing and the light is flashing, the unit has experienced a power outage.

### MESSAGE WAITING

This unit's **MESSAGE WAITING DETECTION** is for both FSK and Stutter Tone Systems.

#### IF YOUR SERVICE IS FSK:

1. If you have a voice mailbox service from the phone company, the MESSAGE indicator will flash and [MESSAGE WAITING] will appear on the display for 20 seconds when a message waiting signal (on) from the Central Office is received.
2. The MESSAGE indicator will go off and [MSG WAITING OFF] will appear for 20

seconds if the message waiting off signal is sent from the Central office.

**IF YOU ARE IN AN AREA WHERE AN FSK SIGNAL IS NOT AVAILABLE:**

1. This unit will check your line for a stutter dial tone every time you hang up or each time a call goes unanswered. The **MESSAGE** indicator will flash when there is a message waiting.
2. You may experience some delay in seeing the **MESSAGE** indicator light up even though there are messages in your mail box. This delay is due to regulatory matters and does not indicate a problem with the unit.

This unit may not be activated or deactivated under certain conditions. For example, when you retrieve your message from an outside phone (not your own telephone number), the **MESSAGE** indicator may not be canceled when you return home. If you experience this situation, pick up the receiver and hang up. The **MESSAGE** indicator will cancel.

**RECEIVING CALLS**

1. When the telephone is not in use and a new call is received, the display will show the **NEW** symbol, the phone number, the caller's name, and time and date of the call for 20 seconds. The **RPT** (repeat) symbol will appear if the call has come in more than once.

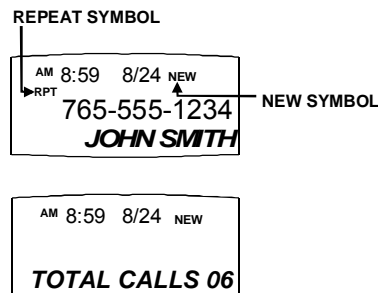

2. After 20 seconds with no activity, the display will default to the Stand-By screen and remain on until another call is received or a button is pressed. This will show you the total number of calls stored.

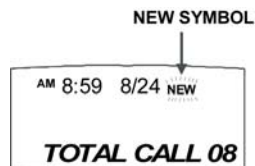

### REVIEWING CALLS

1. When the **NEW** symbol is flashing on the Stand-By screen, you have new incoming calls. Press the **REVIEW UP** (▲) or **REVIEW DOWN** (▼) button to review the incoming stored calls.
2. The **NEW** symbol attached to each call will be removed after you review the call.
3. If the **NEW** symbol is still flashing when the display goes back to the Stand-By screen, there are new calls that you have not yet reviewed.
4. The reviewed number can be stored into any of the auto memory buttons or keypad memory locations by pressing the **STORE** button first, then one of the memory buttons
5. When you have reached the end of the call records, the display will indicate [-**END OF LIST**-], confirming there are no more calls stored.



**- END OF LIST -**

**Note:** If the telephone number received is more than 10 digits, the unit will only store the first 10 digits into memory.

### DELETING CALLS

1. To delete an individual call: When reviewing calls, you can delete an individual call by pressing the **DELETE** button once. The display will be erased line by line and the rest of the records will be renumbered.



**703-555-1234**  
**JOHN SMITH**

2. To delete all calls: When reviewing calls, you can delete all calls by pressing and holding **DELETE** for more than 3 seconds. Then [**DELETE ALL**] will appear. Press **DELETE** to confirm you really want to erase all records. [**-NO CALLS-**] appears on the display to show there are no calls stored in memory.

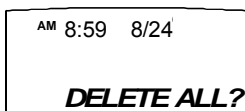

**AM 8:59 8/24**  
**DELETE ALL?**

### CALLBACK

When reviewing received calls, there are two ways to dial the telephone numbers shown on the display by pressing **DIAL**.

1. With the handset in its cradle (on-hook), press **DIAL**. [*PICKUP PHONE...*] will appear in the LCD display to ask you to pick up the handset. The number will be dialed after you pick up the handset.

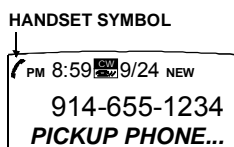

2. If you pick up the handset, review the calls, and press **DIAL**, the displayed number will be dialed immediately.

**Note:** The *HANDSET* symbol will light up in the upper left hand corner of the LCD display when the handset is picked up.

If [*SET AREA CODE*] appears prior to [*PICKUP PHONE...*] or dialing, it means you have not programmed the local *area* code. Please hang up the telephone and program the *area* code.

1. If a local call (a telephone number with the same area code as you set) is reviewed and its 7-digit number displayed, press **DIAL** to dial the number displayed.
2. If a long distance call (a telephone number with a different area code than you set) is reviewed and its 10-digit number (3-digit area code + 7-digit telephone number) is displayed, press **DIAL** to dial the number displayed.

### OPTIONS BUTTON

The **OPTIONS** button allows you to change the format of the displayed number. The available format follows:

7-digit	7-digit telephone number.
10-digit	3-digit area code + 7-digit telephone number.
11-digit	long distance code 1 + 3-digit area code + 7digit telephone number.

If a local call, and its 7-digit number is displayed:

- Pressing **OPTIONS** once will change it to a 10-digit format (your area code + 7-digit number).
- Pressing **OPTIONS** twice will change it to an 11-digit number (1 + your area code + 7-digit telephone number).
- Pressing **OPTIONS** three times will go back to the original 7-digit telephone number.

For example: Your area code is 205 and you are reviewing telephone number 785-2883. When the desired format of the telephone number is reached, press **DIAL** to dial the displayed number.

Original 785-2883	Press Option button once (205) 785-2883	Press Option button twice 1 + (205) 785-2883
PM 10:36 8/24 <b>785 - 2883</b> <b>DANIEL WHITE</b>	PM 10:36 8/24 <b>205 - 785 - 2883</b> <b>DANIEL WHITE</b>	PM 10:36 8/24 <b>120 - 578 - 5288</b> <b>DANIEL WHITE</b>

*Note: Since the LCD can only display 10 digit telephone numbers, when you change the format to 11-digits, only the first 10 digits can be seen, but it will dial 11-digits after you press **DIAL**.*

If a long distance call, and its 10-digit number is displayed,

- Pressing **OPTIONS** once will change it to an 11-digit number (1+ 3-digit area code + 7-digit telephone number).
- Pressing **OPTIONS** twice will remove the 3-digit area code and change to display only the 7-digit telephone number.
- Pressing **OPTIONS** three times will go back to the original 10-digit number.

For example: your own area code is 205, and you are reviewing telephone number 914-656-5756.

When the desired format of the telephone number is reached, press **DIAL** to dial the displayed number.

Original (914) 656-5756	Press Option button once 1+(914) 656-5756	Press Option button twice 656-5756
PM 8:29 8/24 <b>914 - 656 - 5756</b> <b>SMITH JOHN</b>	PM 8:29 8/24 <b>191 - 465 - 6575</b> <b>SMITH JOHN</b>	PM 8:29 8/24 <b>656 - 5756</b> <b>SMITH JOHN</b>

### MESSAGE ERROR

- The display indicates [-ERROR-] if your unit receives a call that has an error in the transmission or reception.

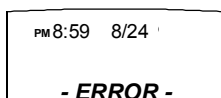

### NODATA SENT

- [-NO DATA SENT-] will be displayed if there is no caller ID (CID) number sent from the telephone company while ringing.

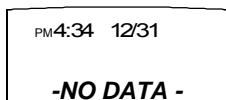

### PRIVATE CALLS

- If the caller has exercised the option to block his number from being sent, [PRIVATE NUMBER] and his name will alternately display on the screen when this information is received.
- If the caller has exercised the option to block his name from being sent, [PRIVATE NAME] and his telephone number will be displayed on the screen.
- If the caller has exercised the option to block his name and number from being sent, then [PRIVATE CALLER] will be displayed on the screen.

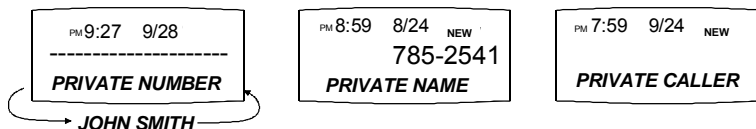

### UNKNOWN CALLS

- When the telephone company is unable to provide information of the caller's telephone number, [UNKNOWNNUMBER] and his name will alternately display on the screen when this information is received.
- When the telephone company is unable to provide information of the caller's name, [UNKNOWNNAME] and his telephone number will be displayed on the screen.
- When the telephone company is unable to provide information of the caller's name and number, [UNKNOWN CALLER] will be displayed on the screen.

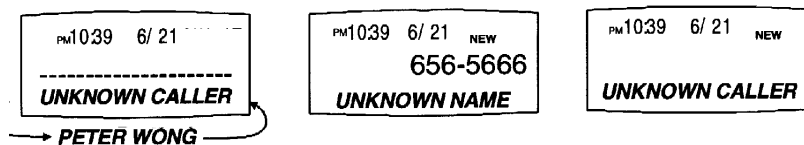

### CALL WAITING DELUXE

The following features require Call Waiting Deluxe or Type 2.5 Caller ID service provided by your telephone company. When you hear the call *waiting* beep, you can choose from a variety of advanced Call Waiting options.

- **CALL WAITING** - To answer an incoming call while putting the person you are talking to on hold, press **FLASH**.
- **TO VOICE MAIL** - To forward an incoming call to voice mail so that you can finish your current call and listen to the new one later, press **TO VOICE MAIL**.
- **PLEASE WAIT** - To connect an incoming call to an announcement which states you will be with the new caller shortly, press **PLEASE WAIT**. This feature should be used if you do not want to be interrupted and can take the other call soon.
- **CALLBACK** - To connect the incoming call to an announcement asking the caller to call back at a later time, press **CALL BACK**.
- **3-WAY CALL** - To add the incoming person to your existing conversation in a 3-way call, press **3-WAY CALL**.

*Note: If you choose not to use any of the Call Waiting Deluxe options, you may simply ignore the call waiting beeps and continue your conversation. The person calling will hear a continuous ring, as if you are not home, or may be transferred to a voice mail account if available.*

## **TELEPHONE SERVICE PROBLEMS**

**If you have any problems with your telephone equipment service**, determine if the problem is with your unit or the telephone company lines. **BEFORE CALLING THE TELEPHONE COMPANY**, be aware that they may charge you for a service call if the problem is caused by your telephone equipment.

### **TROUBLESHOOTING**

#### **PHONE DOES NOT RING**

1. **OFF/LOW/HI** ringer switch is set to **OFF** position
2. Line cord is disconnected at telephone outlet or at telephone end.
3. Phone is **OFF HOOK**. Make certain the hookswitch is depressed when the handset is in the cradle.
4. **SPEAKERPHONE** indicator is on. Turn off speakerphone.

#### **NO DIAL TONE**

- Wire is disconnected at telephone jack or at wall jack. Test the telephone in a different wall jack. If it works, the first jack may be defective.

#### **HAVE DIAL TONE BUT CANNOT DIAL OUT**

- Check if the **PULSE/TONE** switch is at the correct position.

#### **REDIAL BUTTON DOES NOT FUNCTION**

- The telephone may have been momentarily disconnected from the telephone jack.

#### **SPEAKERPHONE BUTTON DOES NOT FUNCTION**

- The headset switch is turned to the **ON** position, Turn to **OFF** position.

#### **BLANK SCREEN**

- Check if the adapter is connected properly

#### **CALLERS ARE NOT DISPLAYED ON THE SCREEN**

1. Verify that you have subscribed to the appropriate service (Caller ID and Call Waiting Caller ID) from your telephone company. If you only subscribed to the Caller ID service this unit will not display the call waiting caller ID information.
2. Check if your answering machine is set to answer the call before 2 rings.



## **NO CALLER INFORMATION IS DISPLAYED WHEN HEARING THE CALL WAITING**

### **AUDIO SOUND**

- Verify that you have subscribed to the Call Waiting Caller ID service from your telephone company.

### **MESSAGE ERROR HAPPENS FREQUENTLY**

- Caller information was not transmitted properly. Check with your telephone company to see if there is a problem with your phone line.

Since our special design will always retain your stored call records, we encourage you to disconnect all the telephone cords and adapter; and then reinstall the unit step by step per this instruction manual before you ask for service.

**SPECIAL NOTE:** *The call records will not be erased when the adapter is disconnected. A special E2PROM design allows the unit to always retain your stored call records after you disconnect the adapter.*

## **MAINTENANCE INFORMATION**

**Treat your telephone equipment with care** for trouble-free performance. Avoid dropping the handset. Carefully place the handset on-hook after use.

Avoid putting near heating appliances and devices that generate electrical noise (for example, motors and florescent lamps).

**Clean your telephone equipment with a damp cloth.** Stains may be removed with a mild soap. Do not use liquid or aerosol detergents or cleaning agents.

**Do not** expose to direct sunlight or moisture

Retain the original package in case you need to ship it at a later date.

## TELEPHONE REPAIR

**DO NOT ATTEMPT TO REPAIR THIS PRODUCT YOURSELF.** Call Waiting Caller ID Telephones manufactured by CORTELCO must be returned to us for repair.

**You can return your telephone to CORTELCO** for repair or replacement in accordance with our LIMITED WARRANTY.

CORTELCO warrants **THIS PRODUCT** against defects in material and workmanship in accordance with our LIMITED WARRANTY. If your telephone is returned for repair, include a copy of your sales receipt containing the date-of-purchase. **DO NOT INCLUDE THE ORIGINAL SALES RECEIPT.**

**If date-of-purchase is not included,** the factory date printed on the label on the bottom of your telephone will be used as the date-of-purchase. The factory date allows six months for distribution and sale of this product.

**If you return your telephone for repair,** the warranty period is not extended. The original date-of-purchase continues to apply to your warranty.

**OUT-OF-WARRANTY REPAIR** We will repair this product for a nominal fee after the LIMITED WARRANTY has expired if you send it to us in a complete and undamaged condition. The repaired Call Waiting ID will be shipped to you C.O.D., freight collect.

**RETURN-FOR-REPAIR PACKAGING** If you are returning a unit to us for repair, package it carefully, preferably in the original carton. Be sure to include your return address, a copy of the sales receipt showing date-of-purchase, and a note describing the problem you have with your Call Waiting Caller ID Telephone. Shipping must be prepaid. If the telephone is in warranty, it will be repaired or replaced, at our option, at no cost to you, and it will be returned shipping prepaid.

Ship your Call Waiting Caller ID (shipping prepaid) to:

CORTELCO  
REPAIRCENTER  
1703 SAWYER ROAD  
CORINTH, MS 38834

## FCC INFORMATION

**Part 68** is a Federal regulation which requires equipment to be tested and registered with the FCC prior to its connection to the network. This equipment complies with Part 68 of FCC rules. On the bottom of the telephone is a label that contains, among other information, the FCC Registration Number and the Ringer Equivalence Number (REN) for this equipment. You must, upon request, provide this information to your telephone company.

The **Ringer Equivalence Number**, which is used to determine the number of devices you may connect to your phone line, indicates the amount of power that your telephone draws from the telephone company line during ringing. If you have more than one telephone (or other terminal device) connected to the telephone company line, you should total the ringer equivalence numbers (REN s), and be sure that the total is not more than five. Your telephones may not ring if the total is more than five. Also, in some rural locations, your telephone may not ring if the REN total is more than three.

**RESTRICTIONS** You must not connect your telephone to coin-operated lines or party lines.

**INSTALLATION** This model telephone must be connected to the telephone company lines through a modular jack. The required USOC for the modular jack is RJ11C for desk mounting and RJ11W for wall mounting. The USOC number is printed on the label on the bottom of your telephone.

**HEARING-AID COMPATIBILITY** The handset on your telephone will work with magnetically-coupled hearing aids. You can use a hearing aid equipped with a T (Telephone) switch.

**IN CASE OF TROUBLE** If your telephone should cause problems on the telephone line, the telephone company can temporarily disconnect your service. The telephone company must then notify and allow you to correct the problem.

The telephone company may from time to time change its lines or equipment. They must notify you if planned changes will affect your telephone service, to allow you to take steps to prevent interruptions.

**Part 15** regulates the electromagnetic energy emitted by equipment to minimize interference to radio, television, and other wireless devices. This telephone complies with Part 15 of the FCC Rules. In the unlikely event that interference occurs, move the telephone and/or radio, television, etc. to increase the separation distance.

## LIMITED WARRANTY

If you purchased this product new in the U.S. or Puerto Rico, **CORTELCO** warrants it against defects in material and workmanship for a period of five (5) years from the date of original purchase. This warranty is in lieu of all other express warranties. During the warranty period, **CORTELCO** agrees to repair or, at its option, replace the defective product, or any part of it without charge for parts or labor. This is your exclusive remedy. This warranty does not cover damage resulting from accident, misuse, abuse, improper installation or operation, lack of reasonable care, the affixing of any attachment not provided by **CORTELCO** with the product and loss of parts. The warranty is voided in the event any unauthorized person alters or repairs the unit.

Telephone companies use different types of equipment and offer various types of services to customers. **CORTELCO does not warrant that this product is compatible with the type of equipment of any particular phone company or the services provided by it.**

**CORTELCO** DISCLAIMS ANY IMPLIED WARRANTY, INCLUDING THE WARRANTY OF MERCHANTABILITY AND THE WARRANTY OF FITNESS FOR A PARTICULAR PURPOSE, AS OF THE DATE ONE YEAR FROM THE ORIGINAL PURCHASE OF THE PRODUCT. **CORTELCO** ASSUMES NO RESPONSIBILITY FOR ANY SPECIAL, INCIDENTAL OR CONSEQUENTIAL DAMAGES.

THIS WARRANTY GIVES YOU SPECIFIC LEGAL RIGHTS, AND YOU MAY HAVE OTHER RIGHTS WHICH VARY FROM STATE TO STATE. SOME STATES DO NOT ALLOW THE EXCLUSION OR LIMITATION OF SPECIAL, INCIDENTAL OR CONSEQUENTIAL DAMAGES OR LIMITATIONS ON HOW LONG AN IMPLIED WARRANTY LASTS, SO THE ABOVE EXCLUSION AND LIMITATION MAY NOT APPLY TO YOU.

If failure occurs and your Call Waiting ID is in warranty, service shall be provided by returning it to **CORTELCO - Repair Center, 1703 Sawyer Road, Corinth, Mississippi 38834, shipping prepaid**. The product will be repaired or replaced if examination by us determines the product to be defective. Call Waiting IDs received damaged as a result of shipping will require you to file a claim with the carrier.